

**X-POWER**

**AMICOCIRC**

**Intelligent Frequency  
Conversation Circulation Pump**

**Handbook**

[www.xpowerwaterpumps.com](http://www.xpowerwaterpumps.com)



# Index

**Cautions** **Pag. 01**

---

**Product Overview** **Pag. 02**

---

**Nomenclature** **Pag. 03**

---

**Installation and Usage** **Pag. 03/06**

---

**Electrical Connections** **Pag. 07**

---

**Operation Instructions** **Pag. 08/15**

---

**Performance** **Pag. 16/17**

---

**Technical Data and Dimensions** **Pag. 17/18**

---

**Problems Solving** **Pag. 19**

---

**Warranty** **Pag. 20**

---

# Cautions

1. Read and understand this user manual before installation and operation of the product.
2. The warning sign marks notes whose non-observance will endanger your health or the functioning of the device.
3. The user has to rely on a qualified staff, able to fully understand the electrical regulations and this manual.
4. Do not install the pump in a damp place or where there may be water splashes.
5. For easy maintenance, shut-off valves should be installed in both suction and discharge lines.
6. During installation and maintenance, we recommend to cut off the pump power supply.
7. It is strictly forbidden to start the pump without pumping liquid.
8. Always shut down the pump before touching or proceeding with any intervention on it. Allow all system and pump components to cool, before you handle them.
9. Please pay attention to ventilation in case of moisture condensation, causing electrical fault.
10. At low temperatures, we recommend to remove the liquid inside the pipelines to avoid cracking.
11. In the perspective of long periods of inactivity, make sure to close the inlet and outlet valves.
12. If the supply cord or the plug are damaged, please ask a qualified centre to replace them.
13. If the temperature of the pump is greater than the value of nameplate, remove the power, disconnect the pump through the valves on the pipeline, and please contact your local dealer or service.
14. If you are unable to find a solution to a potential problem, please contact your local support centre.
15. Keep out of reach of children.
16. Install the pump in a dry and well ventilated area.
17. The network and relative outlets must be fitted with an efficient earthing connection following the laws in force on the matter of electrical systems.

## 1. AMICO

The AMICO Circulator is synonymous of quality and safety.

Quiet and powerful, it is designed to ensure a considerable energy saving.

It is suitable for domestic applications, heating systems and hot water circulation. Innovative and easy to install, it is used in heating and air conditioning systems.

The permanent magnet technology, combined with the frequency converter, allowing the engine to run automatically, according to the real needs.

## 2. Main Features

- 1) Simple and compact structure.
- 2) Different adaptive control modes.
- 3) Combine control over two different compression pressure differences.
- 4) Display actual consumption power.
- 5) Low noise.
- 6) Energy-saving setup (Auto Night Mode).
- 7) Permanent magnet motor and compact design of stator.
- 8) Intelligent frequency conversion system
- 9) Coefficient  $EEI \leq 0,22$
- 10) Protection grade: IP42
- 11) Pressure: Max. 1,0MPa (10Bar)

## 3. Settings

- 1) The operating point of the water can be: "constant flow " or "variable flow".
- 2) You can set three (3) different "fixed speed" (I, II, III).
- 3) Temperature variation system.

## 4. Pumping liquid

Clean, thin, non-aggressive and non-explosive liquid without solid particles or mineral oils.

The pumping liquid should meet the water quality standard involved, both in heating systems and in recirculation systems of sanitary water.

Liquid temperature range: +2 °C to +110 °C

# Nomenclature

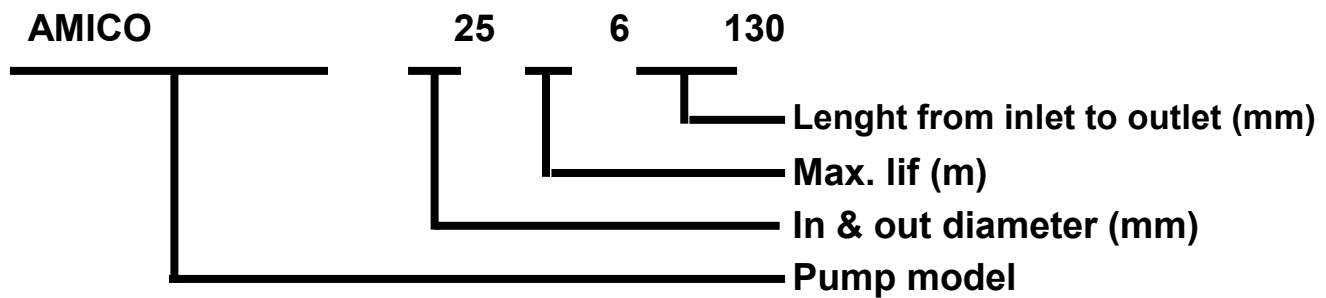

## Installation and Usage

### 1. Installation Instructions

- Before installation please check:
  - 1)if there are impurities in the piping system;
  - 2)that the power frequency is 50Hz/60Hz with voltage of 230Vac and voltage fluctuation value between -10% to +6%.
- The pump should be installed in dry and ventilated area, away from water splashing, to avoid short circuit.
- For easy maintenance, we recommend to install a shutoff valve at both sides of the inlet and outlet of the pump.
- If the pump is installed in the open air, it should be added a protection cover. For indoor installation, it should prevent from splashing, which might cause electric shock. Do not install the pump in wet or damp areas.
- After installing the pump, carry out test running with power on. Then set up the speed control switch to the S3 speed and check if AMICO starts normally.
- The network and relative outlets must be fitted with an efficient earthing connection following the laws in force on the matter of electrical systems.
- Do not change the power ground plug without authorization.
- Please affix a warning sign on the pump operating site.
- Regularly check the pump insulation resistance. The cold insulation resistance should not be less than 50MΩ (MW).
- If the cable is damaged, it must be replaced with an original X-Power electric cord.

## 2. Installation of Amico Circulator

The arrows on the pump housing indicate the direction of liquid flowing through the pump.

### 2.1 Installation

(Fig. 1)

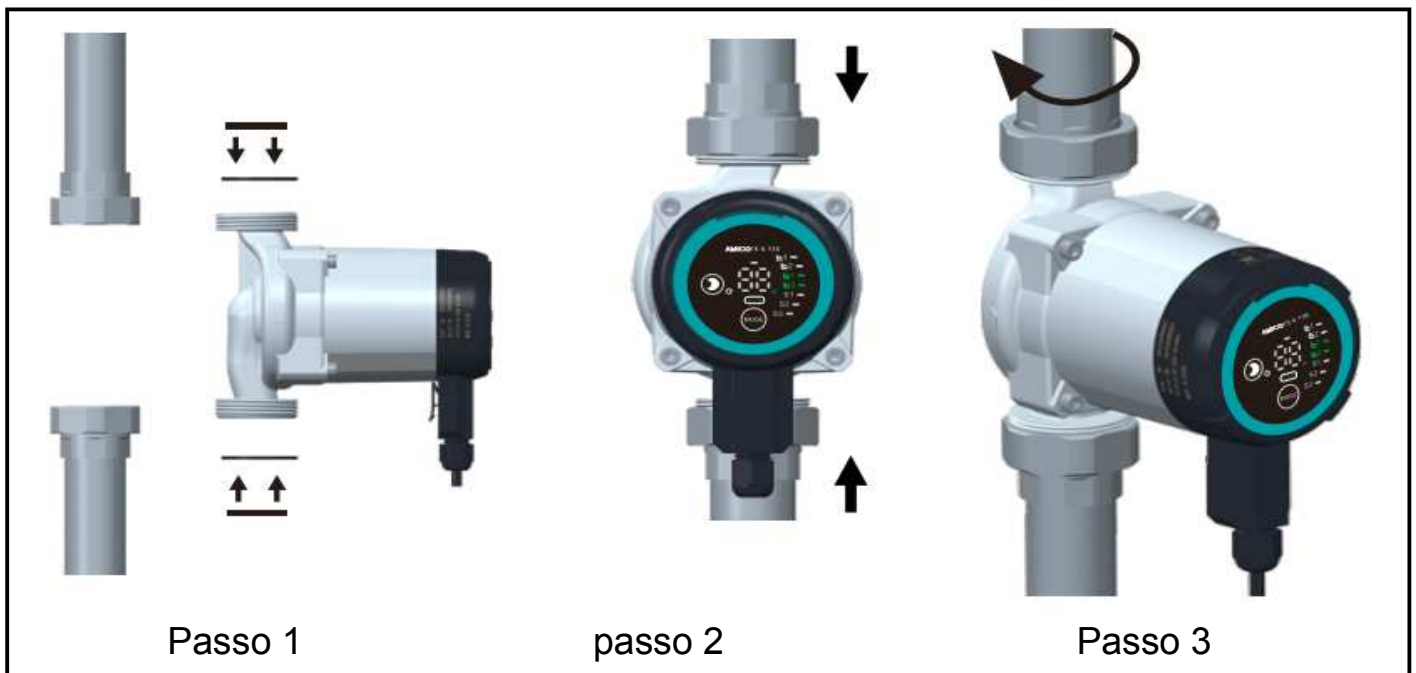

(Fig. 2)

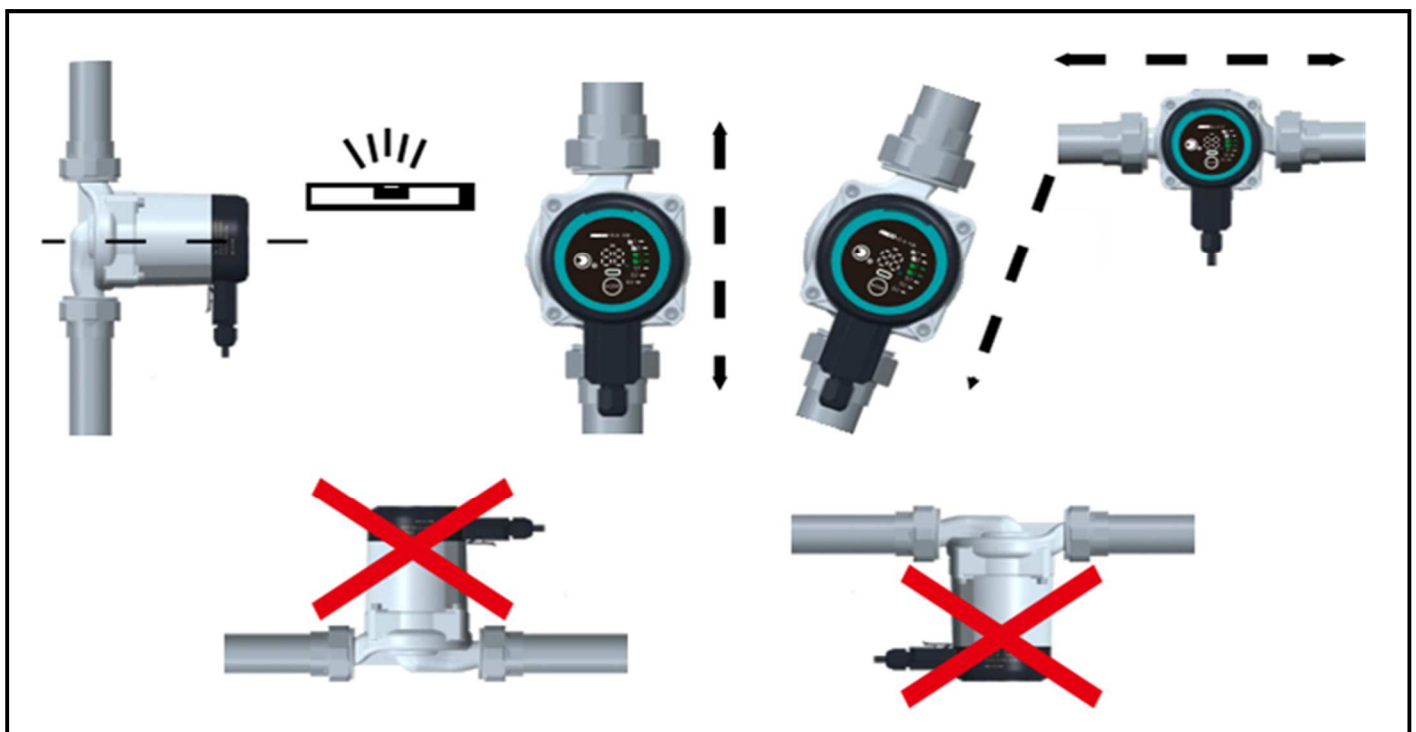

- 1) You must install two sealed gaskets.( fig1).
- 2) When installing, the motor shaft should be horizontal (fig.2).

## 2.2 Location of Junction Box

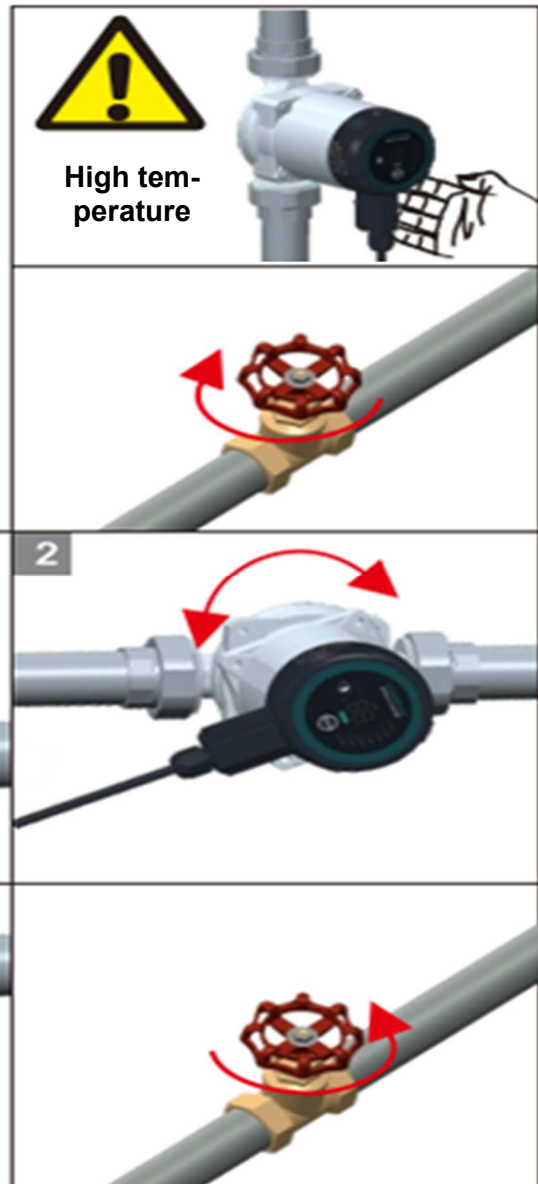
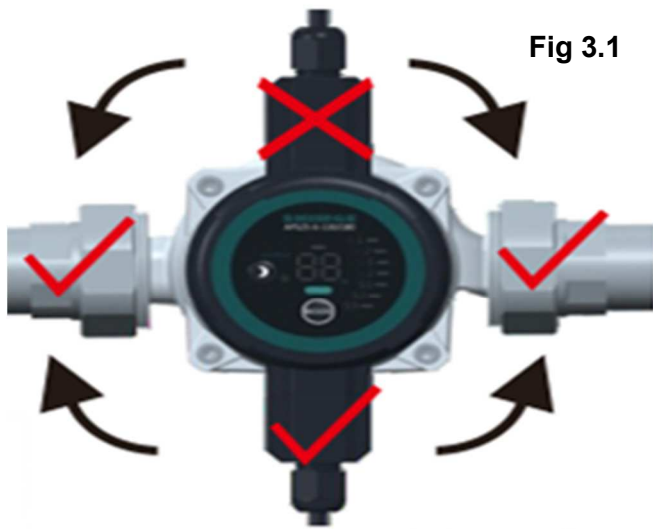

## 2.3 Different positions of the Junction Box

The junction box can be turned with 90 °C, as a gear.  
But you can also change the installation position of the box  
(Figure 3.1).

Loosen and remove the four screws holding the pump head  
(Figure 1).

Turn the pump head to the desired position. (Figure 2).

Replace the four hex screws. Bolt and tighten crosswise. (Figure 3).



### WARNING!

The pump housing might be incandescent. It can cause scalds and burns. Before any intervention on the circulator, you have to drain the system and close the valves.



## 2.4 Pump Body and Heat Insulation System

The "system temperature" must be higher than the "environment temperature", to avoid an excessive condensation on the pump housing.

Please refer to the temperature instructions on the product label.



(Strictly avoid isolating the electronic pump head)



**WARNING!**  
Do not insulate or cover the junction box and the control panel.

# Electrical Connections

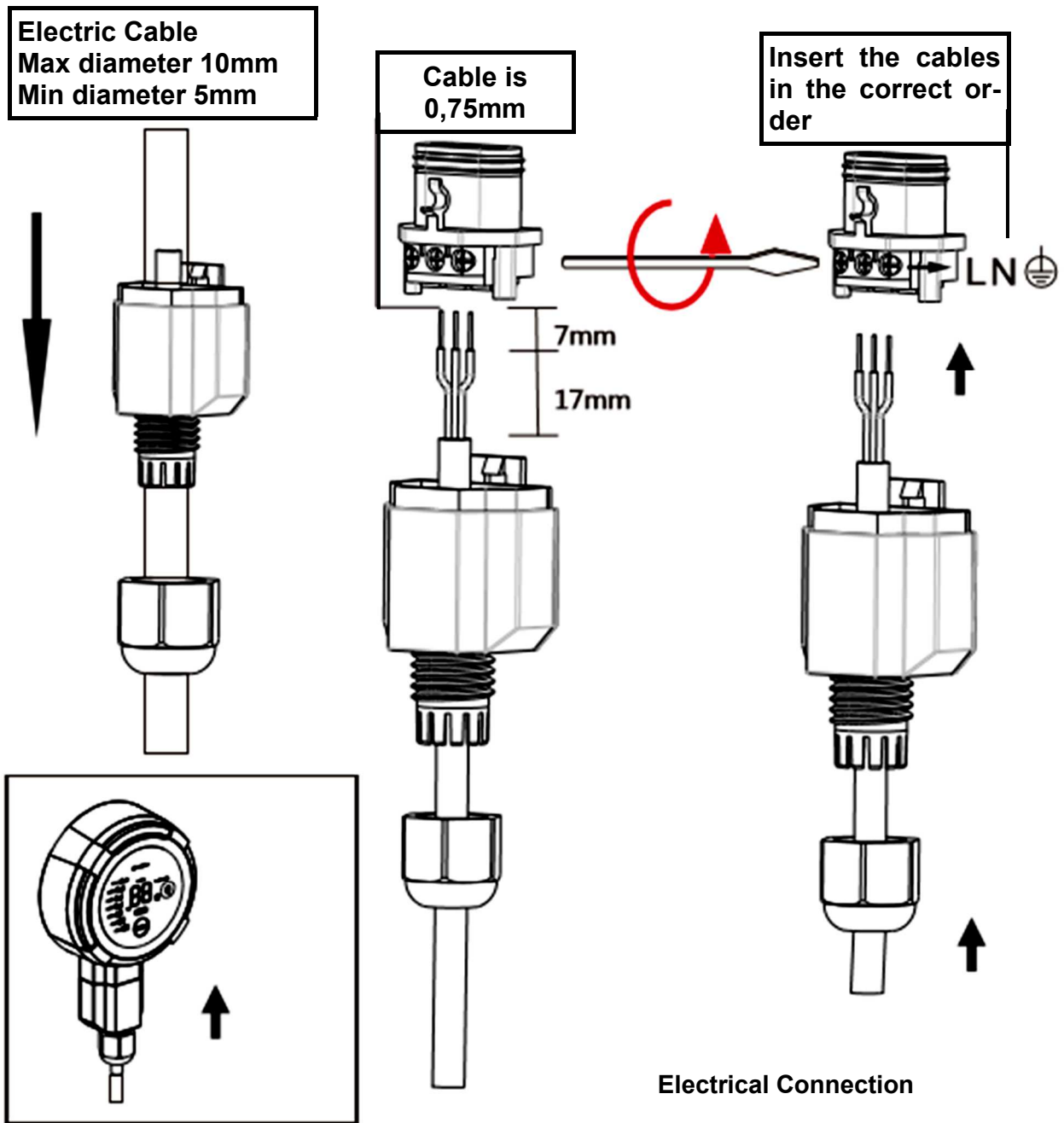

AMICO Circulator doesn't need an external motor protection.  
Check if voltage and frequency are consistent with values in the pump plate.

The circulator is working when the control-panel-light turns on.

If the power cord is damaged, it must be replaced.

Protection fuse: 1A.

# Operation Instructions

## 1. Operation Panel

### 1.1 Operating instructions for control panel

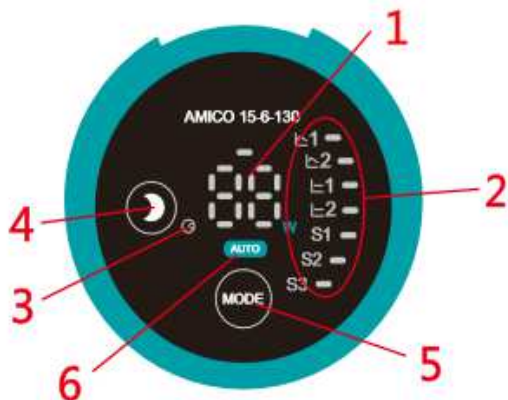

- 1) Actual consumption in Watt
- 2) Lighting set up areas
- 3) Night Mode: ON
- 4) Automatic Night Mode
- 5) Change settings Button
- 6) Auto-function and display light area

### 1.2 Description of side plate

The following descriptions are written on the pump and on the packaging box.

- 1) Serial n° 2012102560001
- 2) TF110 IP42 220/240V 50/60Hz
- 3) [www.xpowerwaterpumps.com](http://www.xpowerwaterpumps.com)
- 4) [info@xpowerwaterpumps.com](mailto:info@xpowerwaterpumps.com)



	6	7	8
	I (A)	P (W)	MPa
Min.	0,04	4,5	—
Max.	0,35	45	1,0

Location	Description
1	Serial Number
2	Temperature grade - Protection - Volt - Frequency
3	Internet address of the distributor
4	Distributor contact
5	Marks and certifications
6	Rated current (A) Min. (Mode Min) (A) Max. (Mode Max) (A)
7	Input power P1 (Watt) Min (Mode Min) P1 Watt Max. (Mode Max) P1 Watt
8	Maximum permissible operating pressure

## 2. Display Description

1) 2.1 After starting, the led in location 1 (Actual consumption in Watt) lights.

2.2 Actual power pump consumption signal.

2.3 Failure, that disables the normal running of the pump, will be displayed as: "- -" .

## 3. Lighting Area that shows Pump Setting

AMICO pump has eight settings (AUTO, PP1, PP2, CP1, CP2, I, II, III) indicated by 8 different led areas, which can be achieved through buttons.



Press (number of times)	Led Area	Description
0	AUTO	Auto-adaption
1	PP1	Min. proportional pressure curve
2	PP2	Max. proportional pressure curve
3	CP1	Min. constant pressure curve
4	CP2	Max. constant pressure curve
5	I	Constant speed I
6	II	Constant speed II
7	III	Constant speed III
8	AUTO	Auto-adaption

## 4. Led area that shows the Automatic Night Mode

It is indicated with  When this Led is on, the Auto Night Mode is activated.

## 5. Auto Night Mode Button

It is characterized by the half moon and it is located in 4.

If one of the constant speeds (I, II, III) is activated, it is impossible to go into Night Mode.

## 6. Select Button

Press the MODE button once to change the settings one at a time.  
Press the MODE button for eight (8) times to slew the entire cycle of the settings.

## 7. Pump setting

### 7.1 Pump setting as per type system

The circulator is factory set on "AUTO".

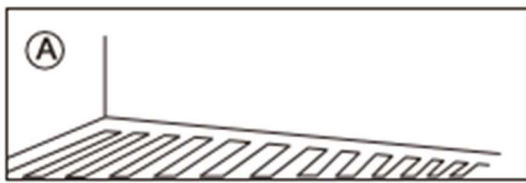

Factory Setting = AUTO Mode

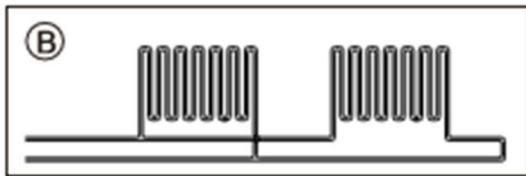

Recommended settings refer to the illustrations on the side.

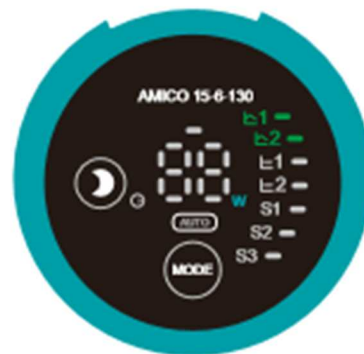
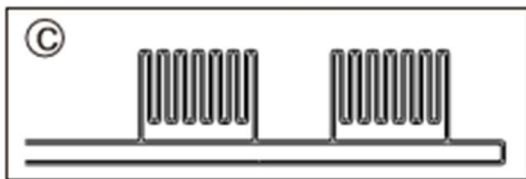

Location	Type System	Pump Setting	
		Best setting	Other settings
A	Floor heating system	AUTO	Constant pressure (CP2) Constant pressure (CP1)
B	Double pipeline heating system	AUTO	Max. proportional pressure (PP2)
C	Single pipeline heating system	Min. proportional pressure (PP1)	Max. proportional pressure (PP2)

The AUTO Mode is usually installed in heating systems with double-pipes-stems. The pump modulates the yield according to the actual demand of the pump. With AUTO you can memorize a set-point. The Setting change is based on a slow system. The AMICO pump needs 20 to 30 minutes to get into the new mode. If the setting does not produce the desired results in this time frame, you must edit them.

## 7.2 Pump Control

- The pump performance must be adjusted based on system demand. Setup the pump on "Proportional Pressure" (PP), or on "Constant Pressure" (CP).
- Proportional pressure control: Under this control mode, the pressure difference is controlled by the flow (at both ends of the pump). In the H/Q diagram of proportional pressure curve, it is indicated by PP1 and PP2.
- Constant pressure control: Under this control mode, the pressure difference keeps stable and it is irrelevant to flow (at both ends of the pump). Constant pressure curve is indicated by CP1 and CP2. In Q / H there is a horizontal performance curve.

## 7.3 Auto Night Mode Basic principle

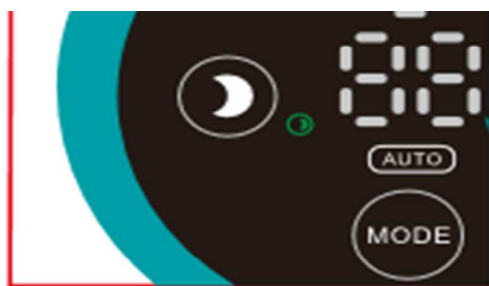

AUTO (automatic adjustment mode) can be set in heating systems with flow and return in two separate pipes.

RED:  
Inlet  
pipe sy-  
stem

BLUE:  
Return  
pipe sy-  
stem

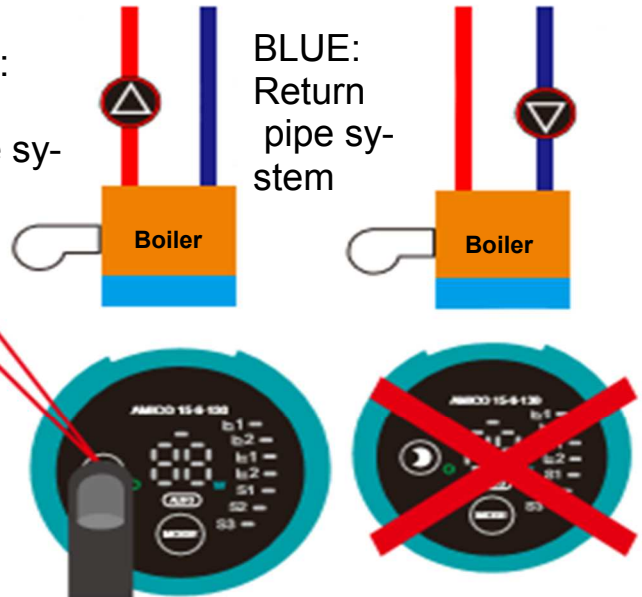

Auto Night MODE



### WARNING!!

AmicoPump installed in heating system with boiler with tank cannot be set to AUTO

## Note:

- ◀ When one of the fixed speeds (S1-S2-S3) is running, night mode does not work.
- ◀ In the event of a power failure, the night mode must be restarted.
- ◀ If the heating system does not provide enough heat, we recommend to disable the night mode.

To ensure NIGHT MODE peak performance:

- The pump must be installed in the water supply pipe, near the water heater.
- If the pump will be installed in the return water pipeline, “auto night mode” will not work.
- The boiler must have an automatic temperature control.
- Press the “Half-Moon Button” to start the “Night Mode”. If the indicator is on, the mode has been enabled.

Once that AUTO NIGHT MODE is enabled, Amico Circulator can be switched between the AUTO MODE and the AUTO NIGHT MODE. Switching between the AUTO MODE and AUTO NIGHT MODE by Amico Circulator is depending on temperature in inlet pipeline (non-return water pipeline) of the system.

If the temperature drop in inlet pipeline system is over 10-15 ° C, the pump will pass mechanically (within two hours) to the AUTO NIGHT MODE .

This temperature drop must at least reach 0,1 ° C / min.

When the temperature of the system rises by about 10 °C, the pump will switch to the AUTO MODE.

## 8. Pipe and Return Water Pipeline

### 8.1 By-pass valve functions

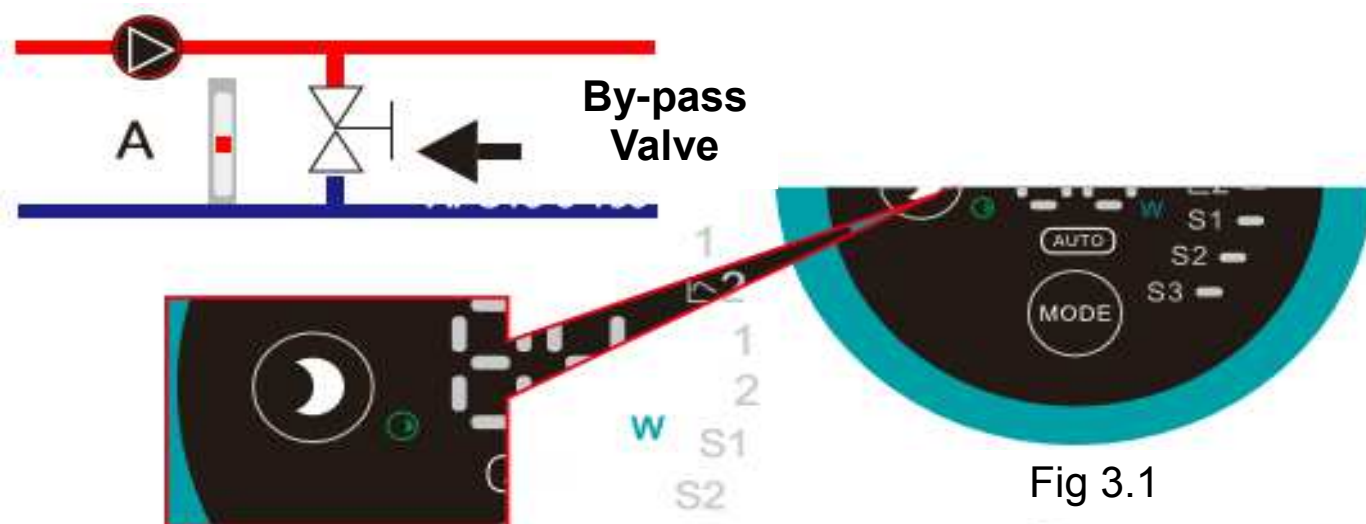
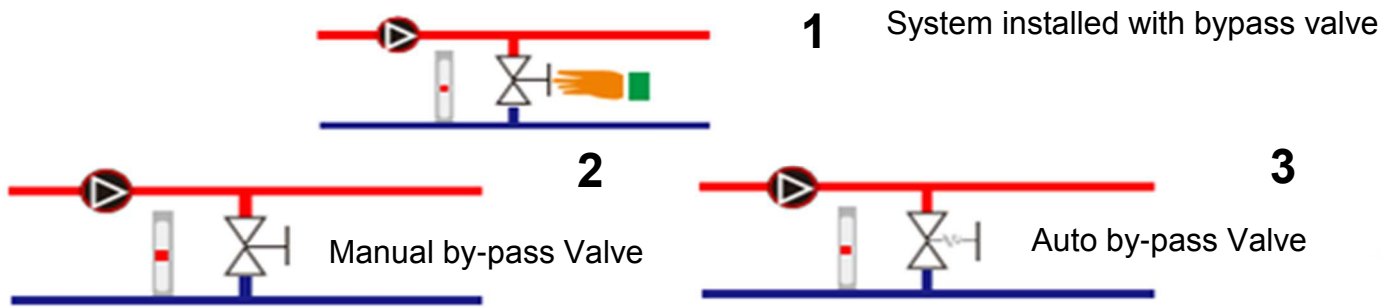

Fig 3.1



## 8.2 By-pass valve

**By-pass valve functions:** The bypass valve can ensure a distribution of heat to the water heater, only when all of the heating system valves are closed.

**Components in the system:**

By-pass valve located between inlet and outlet.

Flow-meter located in A.

When all valves are closed, it is necessary to ensure a minimum flow.

The setting of the circulator depends on the type of valve used; That is to say that, the by-pass valve can be: manual or controlled-temperature.

## 8.3 Manual by-pass valve

Do as follows:

**8.3.1** During adjusting the bay-pass valve, ensure that the pump is in setting Speed I.

It is necessary to ensure a minimum flow to the pump.

**8.3.2** Setup the pump (Chapter 7).

## 8.4 Auto bypass valve (controlled-temperature bypass valve)

Do as follow:

**8.4.1** It is necessary to ensure a minimum flow to the pump.

(Speed I).

**8.4.2** After the adjustment, setup the pump to CP1 Mode (Minimum Constant pressure) or CP2 Mode (Maximum constant pressure).

## 9. Start

**9.1** Before starting the pump, make sure that the system is filled with liquid and that all the air is drained out. The pressure should reach the minimum required level.

**9.2** Switch the setting to Speed III, S3 (self purging function) for a few minutes. Then switch to AUTO mode or change setting.



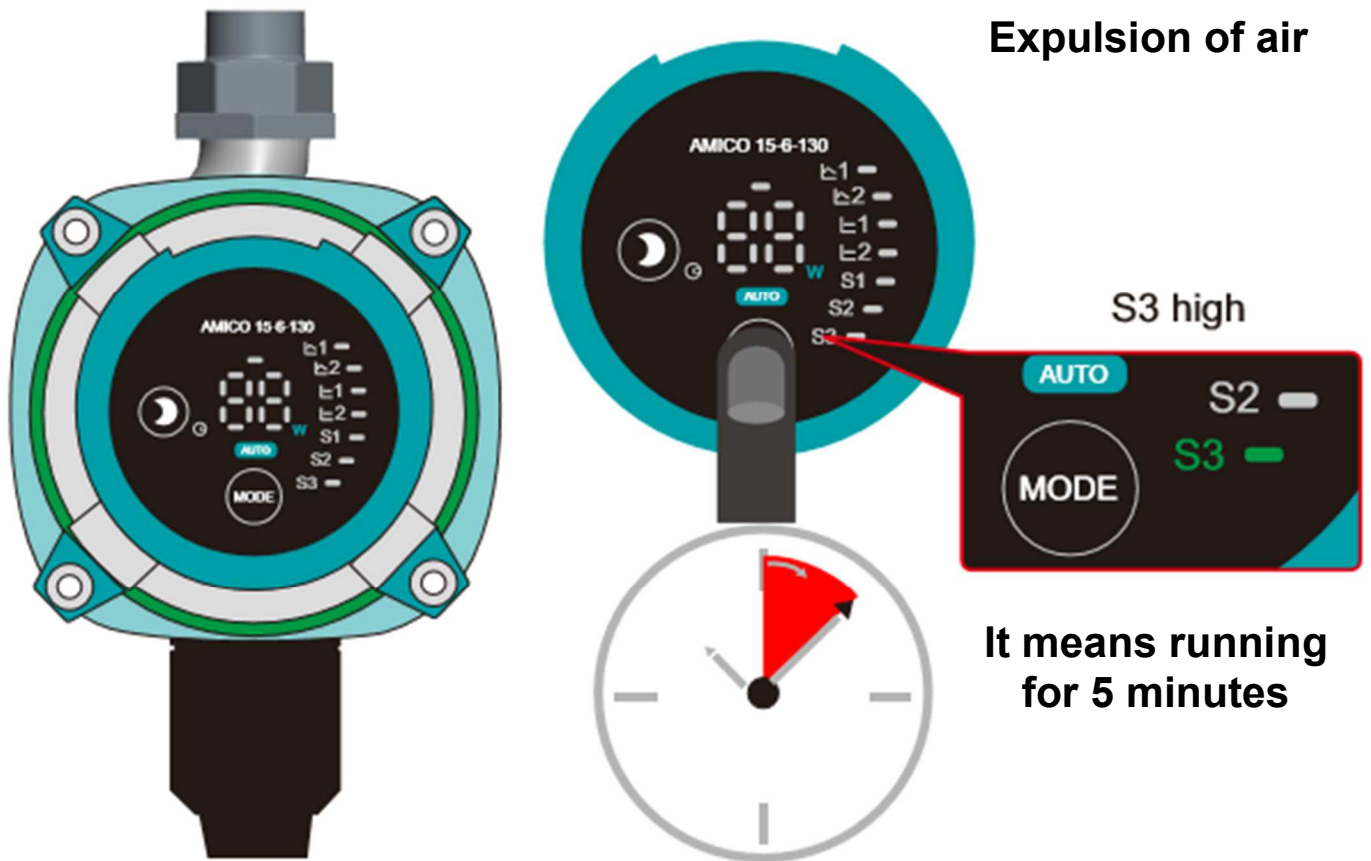

The pump is equipped with the function S3, self purging function. After the start of this setting, the air in the pipes (cause of noise and malfunctions) wears off after a few minutes.

### 10. Relations between pump setting and performance

Such reports shall be expressed in the diagram below.



**Do not start the pump without pumping liquid.  
Do not start the pump before expelling the air in the pipes.**

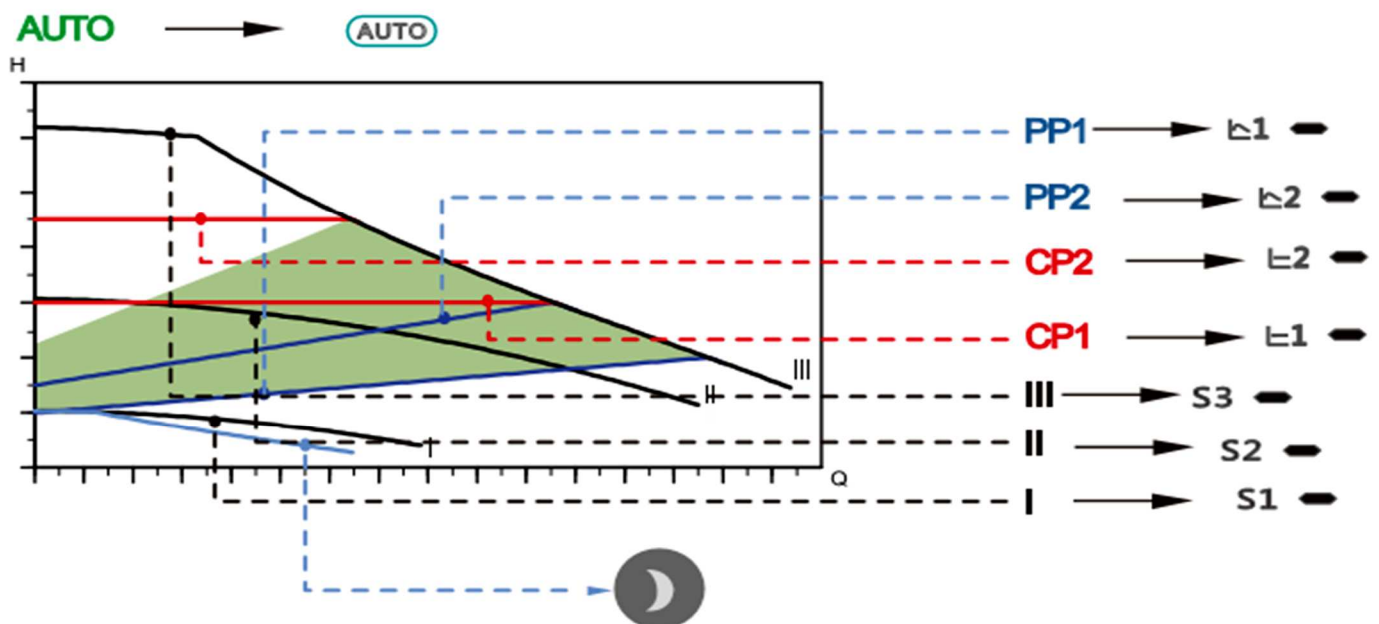

SetUp	Pump features	Function
<b>AUTO</b> Factory setting	Max. to Min. proportional pressure curve	Autoadaptation Mode the performance of pump can be controller within specified range automatically and pump performance can be adjusted as per system scale.
<b>PP1</b>	Min. Proportional pressure curve	The PP1 function allows the pump to work at a lower pressure range (as shown in the graph). The pressure curve is proportional according to the flow required by the system; when demand increases, also pump pressure increases.
<b>PP2</b>	Max. Proportional pressure curve	The PP2 function allows the pump to work at a medium pressure range (as shown in the graph). The pressure curve is proportional according to the flow required by the system; when demand increases, also pump pressure increases.
<b>CP1</b>	Min. constant pressure curve	The CP1 mode allows the pump, in function of the required flow, to work at constant pressure close to the minimum (as reported in the graph).
<b>CP2</b>	Max. constant pressure curve	The CP2 mode allows the pump, in function of the required flow, to work at constant pressure close to the maximum (as reported in the graph).
<b>S1 - I</b>	Speed I	The pump maintains minimum speed (III) set by the operator, in any working condition.
<b>S2 - II</b>	Speed II	The pump maintains average speed (II) set by the operator, in any working condition.
<b>S3 - III</b>	Speed III	The pump maintains maximum speed (I) set by the operator, in any working condition.
	Night Mode	As long as specific conditions are met, Amico will switch to Auto Night Mode and it will be energy saving.

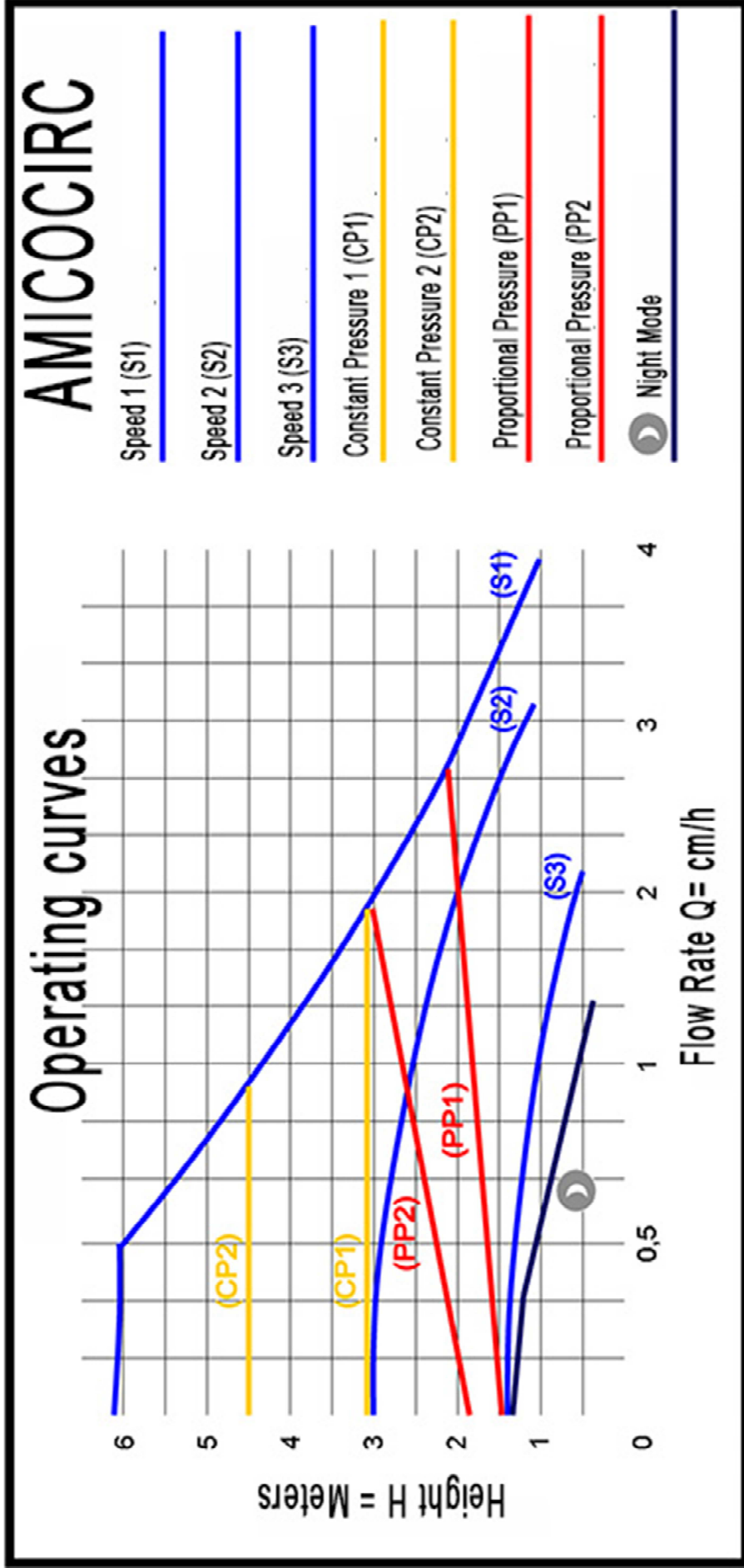

# Technical Data and Dimensions

## 1. Technical Data

<b>Supply voltage</b>	230V / -10% +6% / 50Hz-60Hz, PE
<b>Motor protection</b>	Integrated in the pump head
<b>Protection grade</b>	IP42
<b>Isulation grade</b>	F
<b>Relative amb.humidty</b>	95%
<b>System pressure bearing</b>	Max 1,0Mpa (10 Bar) (100 ml water column)
<b>Suction (inlet) pressure</b>	Liquid temperature      Min.Inlet pressure
	≤ +75°C                      0,005MPa (0,05 Bar) (0,5m. Water column)
	+90°C                        0,028MPa (0,28 Bar) (2,8m. Water column)
	+110°C                      0,108MPa (1,08 Bar) (10,8m. Water column)
<b>Electromagnetic compatibility</b>	EMC standard - EN 61000-6-1 e EN 61000-6-3
<b>Sound pressure level (SPL)</b>	Less than 43 Decibel
<b>Ambient temperature</b>	From 0°C to 40°C
<b>Temperature class</b>	TF110
<b>Surface temperature</b>	Less than 125°C
<b>Liquid temperature</b>	+2°C to +110°C

Ambient Temp (°C)	Liquid Temp.	
	Min. (°C)	Max. (°C)
0	2	110
10	10	110
20	20	110
30	30	110
35	35	90
40	40	70

In domestic hot water system, we recommend to keep the water temperature below 65 °C in order to reduce scale.

## 2. Dimensionale Data

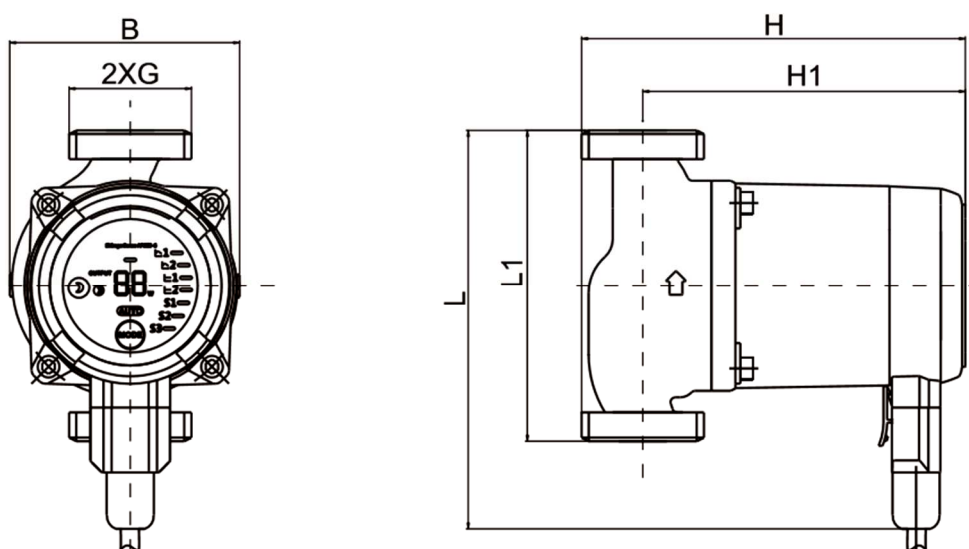

Model	Dimensions						Weight Kg
	H (mm)	H1 (mm)	L (mm)	L1 (mm)	B (mm)	G (")	
<b>AMICO 20-4/5/6-130</b>	156,5	134	166,5	130	95,5	1"	1,94
<b>AMICO 25-4/5/6-130</b>	158	134	166,5	130	95,5	1"1/2	2,12
<b>AMICO 25-4/5/6-180</b>	158	134	191,5	180	95,5	1"1/2	2,27
<b>AMICO 32-4/5/6-180</b>	164	134	191,5	180	95,5	2"	2,46

# Problems Solving



## WARNING!!!

Before any electrical work, make sure the power switch is in the off position.

Control Panel	Causes	Solutions
<b>Light indicators: OFF</b>	A) Burned fuse	Replace the fuse
	B) Break is Off	Put the breaker On
	C) Pump doesn't work	Replace the pump
<b>EO twinkle</b>	A) Pump is blocked	Remove impurities
	B) Pump doesn't work	Replace the pump
<b>E4 twinkle</b>	Over voltage or under voltage	Check the value of the voltage
<b>P5 twinkle</b>	Pump doesn't work	Replace the pump
<b>E2</b>	Pump doesn't work	Replace the pump
<b>0</b>	Pump is blocked	Press MODE button for 2 seconds, within 5 min from the block*

\*If the pump does not start again in a few minutes, one of these LEDs, EO, E4, P5, E2, will be displayed.

## Amico Circulator

### Warranty certificate

Thank you for purchasing this pump, designed and manufactured to exacting high standards, and to confer safety and high quality performance. The legal guarantee starts from the date of purchase and does not cover damage caused by improper use and/or tampering not expressly indicated in this manual.

**For warranty, fill out the following form.**

**Model**

---

**Number**

---

**Invoice numb. or receipt (staple here the sales receipt)**

---

**Date of purchase**

---

**Place of purchase**

---

**Problem**

---



## **UE - Correct Disposal Of This Product**

This symbol identifies important notes regarding the correct disposal of the device.

By disposing of this product correctly you will help ensure that the waste undergoes the necessary treatment, recovery and recycling, and thus prevent potential negative effects on the environment and human health which could otherwise arise due to inappropriate waste handling.

For more information concerning the correct disposal of these products, please contact your reseller.

## **EC DECLARATION OF CONFORMITY**

Elettromek of Germanò Antonino with Headquarters in Via C.Colombo—  
98066 Patti (Me), Italia

Hereby declares that the following X-Power products:

Amico-circ20-4-130 (220V-50/60Hz)  
Amico-circ25-4-130 (220V-50/60Hz)  
Amico-circ25-4-180 (220V-50/60Hz)  
Amico-circ32-4-180 (220V-50/60Hz)  
Amico-circ20-5-130 (220V-50/60Hz)  
Amico-circ25-5-130 (220V-50/60Hz)  
Amico-circ25-5-180 (220V-50/60Hz)  
Amico-circ32-5-180 (220V-50/60Hz)  
Amico-circ20-6-130 (220V-50/60Hz)  
Amico-circ25-6-130 (220V-50/60Hz)  
Amico-circ25-6-180 (220V-50/60Hz)  
Amico-circ32-6-180 (220V-50/60Hz)

Fulfil the relevant provisions of the following europeans directives:

2006/42/CE Machinery Directive  
2004/108/CE Electromagnetic Compatibility Directive  
2006/95/CE Direttiva Low Voltage Directive





